



**DOF6000 Series Ultrasonic Doppler
Open Channel Flowmeter
Manual**

REV 03/2017

Contents

.PART 1 INTRODUCTION.....	3
1.1 Overview	3
1.2 Typical Applications	4
1.3 System Components.....	4
1.4 Getting Started	4
PART 2 OPERATING PRINCIPLES	6
2.1 Overview	6
2.2 How DOF6000 Transducer Measures Velocity.....	6
2.3 Speed of Sound in Water.....	7
2.4 Site Considerations.....	8
2.5 Factors Affecting Data Accuracy.....	10
2.5.1 Alignment with Flow	10
2.5.2 Conversion of Logged to Mean Velocity	10
2.6 Depth Measurement	11
2.7 Flow Rate Calculations	11
PART 3 SPECIFICATIONS	12
3.1 Specifications.....	12
PART 4 FLOW CALCULATOR INSTALLATION AND WIRINGS	14
4.1 Flow Calculator Mounting	14
4.2 Flow Calculator Wirings	14
4.3 Flow Calculator Overview	15
4.4 Flow Calculator wirings and Mounting Dimensions	16
PART 5 DOF6000 TRANSDUCER INSTALLATION AND WIRINGS	18
5.1 DOF6000 Transducer Mounting	18
5.2 Locating DOF6000 Transducer.....	18
5.3 DOF6000 Transducer Pointing Upstream or Downstream?	19

5.4	Power Considerations.....	19
5.5	Signal Cable and Connections.....	20
5.6	DOF6000 Transducer Connection Table.....	20
PART 6 FLOW CALCULATOR OPERATION.....		21
6.1	General.....	21
6.2	Key Instruction.....	21
6.3	Menu Structure.....	22
6.3.1	Communication.....	22
6.3.2	Output.....	23
6.3.3	Data logger.....	23
6.3.4	External L&V.....	23
6.3.5	Service.....	24
6.4	Application Example.....	24
6.4.1	Partially Filled Pipe Examples.....	24
6.4.2	Open Channel Examples.....	25
6.4.3	User Define Examples.....	26
6.5	Offset Area Setting.....	27
PART 7 WARRANTY AND SERVICE.....		28
7.1	Warranty.....	28
7.2	Service.....	28
APPENDIX A – INSTALLATION CHECKLIST.....		29
APPENDIX B – COMMUNICATION PROTOCOL.....		29
APPENDIX C – EXPANDING HOOP.....		31
1.1	Hoop Size Selection.....	31
1.2	Installation.....	32

PART 1 Introduction

DOF6000 Area-Velocity Ultrasonic flow meter is specially intended for flow measurement in partially filled pipes, culverts, channels, streams, rivers and discharge pipe etc. It has great practical utility especially in flow measurement of water conservancy. DOF6000 has been an indispensable tool for energy saving, sewage discharge restriction, reasonable use water resource.



1.1 Overview

DOF6000 Flow Meter consists of flow calculator, 6526 integrated transducer to measure velocity and level at the same time.

The flow calculator can display the velocity, level, flow rate and flow totalizer. It also can be available with 4-20mA, RS485(Modbus)/GPRS and SD card logger outputs. It can record data of flow rate and total flow with a SD card up to 16GB.

The flow calculator can calculate the cross-sectional area of partially filled pipe, open channel stream or river, for stream or river, it can input up to 20 coordinate points describing the river's shape of cross section. It is suitable for various applications.

6526 Velocity and Level Transducer is a unique combination of water velocity, depth and temperature instruments integrated with a solid state logger. It is a new generation of intelligent flow measurement systems.

By using digital signal processing techniques, DOF6000 Transducer is able to perform in a wide range of environments. It is used to record flows in pipes, channels and small streams and operates in a wide range of water qualities from fresh streams to primary sewage channels.

DOF6000 Transducer is mounted on (or near to) the bottom of the stream/pipe/culvert and measures the velocity and depth of the water flowing above it.

DOF6000 systems have been tested in small streams and pipes, and the calibration has been verified in a tow tank. Indications are that different channels have different

characteristics and that acoustics can see velocity distributions that, if they are correct, may challenge some conventional ideas.

1.2 Typical Applications

The instrument is intended for economically recording flows in channels, culverts and pipes. It can also be used where existing techniques are unsuitable or too expensive.

It is particularly useful at sites where no stable stage/velocity relationship exists and where flows are affected by variable tailwater conditions, culvert entry blockages, pipe surcharging, other unstable flow conditions, or even reverse flows.

MODELS

5m depth range (Model H5 DOF6000 Kit).

2m depth range (Model H2 DOF6000 Kit).

1.3 System Components

Your DOF6000 system consists of:

Flow Calculator.

DOF6000 Transducer (including 15m «SQL» compatible signal cable and weatherproof plug).

Adaptor cable for connecting the DOF6000 Transducer to flow calculator.

Stainless Steel Mounting Bracket.

User's Manual.

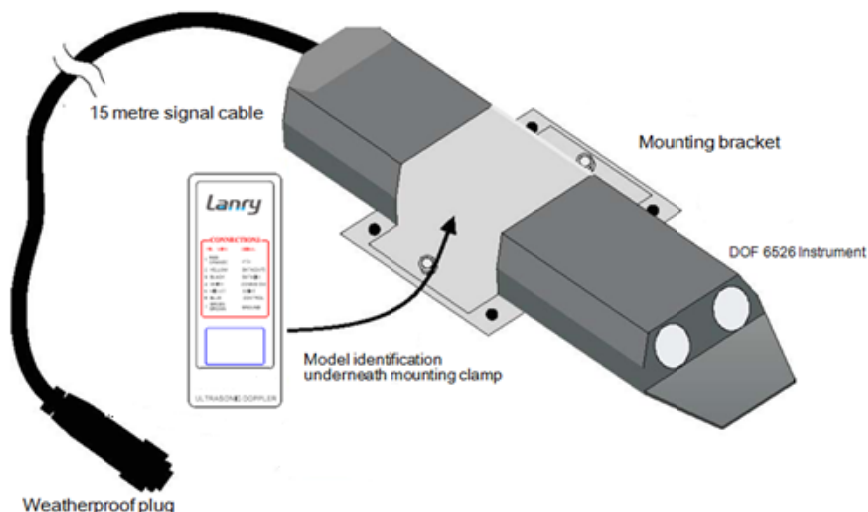

1.4 Getting Started

To use DOF6000, follow these steps:

- 1 Install the Flow Calculator and DOF6000 Transducer in suitable location.

- 2 Connect IN_RS232/485 terminal of flow calculator to DOF6000 Transducer.
- 3 Connect DC12V OUT “+ -” terminal of flow calculator to power DOF6000 Transducer .
- 4 Power on Flow Calculator.
- 5 Set parameters and begin to do the measurement. (Note: Flow Calculator must be set “close” in External L&V)

Parameter setup in flow calculator:

First, set “Close” in “External L&V”;

Second, set measuring type in “Area”; If select “Pipe”, then set pipe diameter, offset and dead zone. If select “Rect”, then set the width of rectangle. If select “UserR”, then set the point coordinates.

The transducer has a 10mm offset, so when using it, the 10mm offset should add to cross-sectional area.

If customer needs output, please set related parameters in “Output”.

Note: When setup parameters in flow calculator, users must connect transducer to flow calculator, if not, pressing key is invalid.

PART 2 Operating Principles

DOF6000 Transducer measures velocity, depth and temperature. The measured data are scaled and processed during presentation and processing.

Connect DOF6000 Transducer to Flow Calculator DOF6000, Flow Calculator can get measured data and display level, velocity, flow rate and total flow. Flow Calculator also can log flow rate and total flow by SD card on main board.

2.1 Overview

Water Velocity in the vicinity of the DOF6000 Transducer is measured acoustically by recording the Doppler shift from particles and microscopic air bubbles carried in the water.

Water Depth above the DOF6000 Transducer is measured by a pressure Transducer recording the hydrostatic pressure of water above the instrument.

Temperature is measured to refine the acoustic recordings. These are related to the speed of sound in water, which is significantly affected by temperature.

Battery Voltage is measured to allow the transducer to stop operating if the supply voltage is below defined limits.

Flow rate and total flow values are computed by flow calculator from user defined channel dimension information.

2.2 How DOF6000 Transducer Measures Velocity

When sound is reflected from a moving target the frequency of the sound is varied by the velocity of the target. This variation is known as a Doppler shift. To measure water velocity in open channels, the transducer exploits the particles moving with the water as acoustic targets (or scatterers) from an instrument fixed to the bed or bank.

There are two distinct types of Doppler instruments that can be used to measure water velocity:

- Coherent (or profiling) Dopplers transmit encoded pulses with the carrier frequency at target locations, and only measure signals reflected from these targets. This allows the velocity in a stream to be profiled. These instruments are complex and expensive.
- Incoherent (or continuous) Dopplers like the DOF6000 Transducer, emit a continuous signal and measure any signals returning from scatterers anywhere and everywhere along the beam. These are resolved to a mean velocity that can be related to a channel velocity at suitable sites.

During a measurement cycle, ultrasonic sound is transmitted continuously at a fixed frequency, called a carrier. A receiver listens for reflected signals from any targets. A measuring circuit detects any frequency changes. A processing system accumulates and analyses these frequency changes and calculates a representative Doppler shift from the range received.

Each Doppler shift is directly related to the water velocity component along the beam. This is a physical relationship and if you know the speed of sound in water you can calculate the velocity of the reflector and thereby the velocity of the surrounding water. The transducers do not need calibration for velocity measurement.

The velocity measured is the component along the beam. Because the beam is at an angle to the flow, the Velocity is adjusted by the angle cosine.

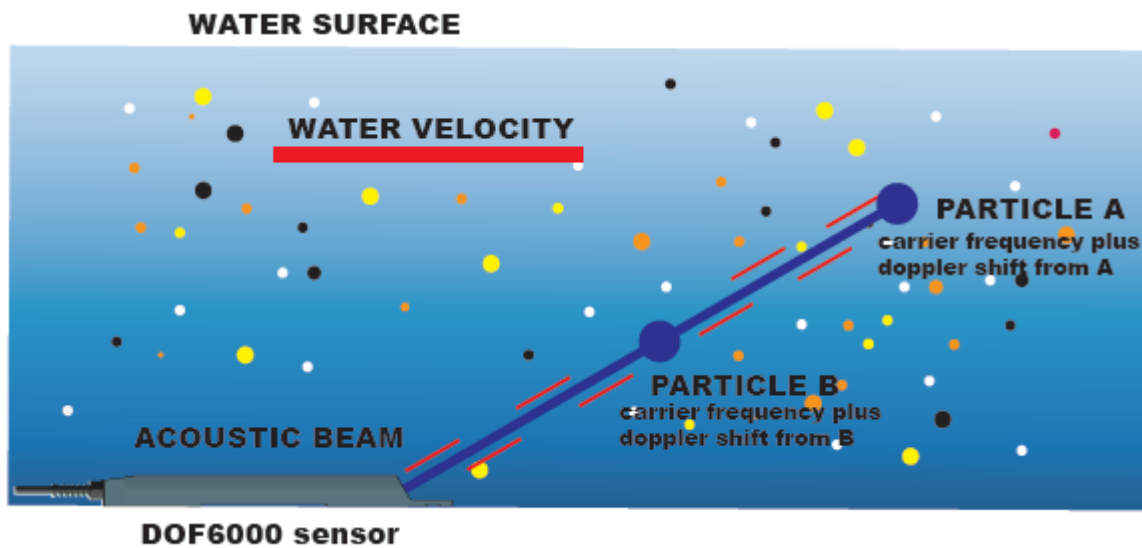

2.3 Speed of Sound in Water

Velocity measurements are directly related to the speed of sound in water. The factor used to scale the transducer Velocity measurement is based on the speed of sound in fresh water at 20°C (see table below). This velocity of sound gives a calibration factor of 0.550mm/sec per Hz of Doppler shift.

This calibration factor may be adjusted for other conditions. For example, the calibration factor for sea water is 0.5618mm/sec/Hz.

The speed of sound varies significantly with water density. Water density is dependent on pressure, water temperature, salinity and sediment content. Of these, temperature has the most significant effect and it is measured by the transducer and applied in the correction of velocity measurements.

The transducer corrects for the variation of the speed of sound in water due to temperature using a factor of 0.00138mm/s/Hz/°C. This correction is a best fit for water temperatures between 0°C to 30°C.

The following table shows how the speed of sound varies with temperature and between fresh and sea water.

VELOCITY OF SOUND IN WATER (m/s) AT ATMOSPHERIC PRESSURE		
TEMPERATURE (°C)	"FRESH WATER"	"SEA WATER"
0	1402	1449
5	1426	1471
10	1447	1490
15	1466	1507
20	1482	1521
25	1497	1534
30	1509	1545
35	1520	1555

Bubbles in the water are desirable as scatterers, but too many can affect the speed of sound. In air the speed of sound is about 350 m/s.

2.4 Site Considerations

The Doppler signal received, and the accuracy of the computed velocity, is related to the flow and cross-section characteristics of the site. A suitable site has the following features:

Feature	Description
Flows are laminar and the velocity measured by the Transducer can be related to the mean velocity of the channel.	Velocity is measured from a limited path in front of and above the acoustic sensors. This area varies with the amount of suspended material in the water and the channel characteristics. The user has to determine the relationship between the measured and mean velocity.
The channel cross section is stable.	The relationship between water level and the cross-sectional area is used as part of the flow computation.
Velocities are greater than 20 mm / second.	The Transducer does not process velocities slower than this. The maximum velocity is 5 metres / second. The Transducer will measure velocities in both directions.
Reflectors are present in the water.	Generally the more material in the water the better. Transducer generally works well in clean natural streams but problems may be encountered in extremely clean water.
No excessive aeration.	Bubbles are good scatterers and occasional small bubbles will enhance the signal. However the speed of sound can be affected if there are excessive amounts of air entrapped in the flow.
The bed is stable and Transducer will not be buried by deposits.	Some coating and partial burying has little effect on the measured velocity but it should be avoided.

Other site considerations relate to the physical suitability for installation and operation of the transducers.

Safe working environment - particularly if you are measuring wastewater pipes or in confined locations.

Access is possible - to check readings of depth and velocity on flow calculator at the Transducer location, to verify the data produced.

Secure installation - resistant to vandalism and as inconspicuous as possible.

2.5 Factors Affecting Data Accuracy

DOF6000 Transducer measures velocity to an accuracy of $\pm 2\%$ and depth to $\pm 0.25\%$ of calibrated range. This is logged to a resolution of 1 mm/sec and 1mm respectively. The transducers have been calibrated and are expected to be stable for long periods provided they are not physically damaged, blocked or buried.

The purpose of the DOF6000 Transducer is to produce FLOW DATA. This is the product of the cross section (derived from measured depth) and velocity data, each of which is modified by user defined factors before use. There are many opportunities for errors to accrue in the process and degrade the result. These can be reduced or eliminated by using the instrument properly. Some of the more significant potential error sources follow.

2.5.1 Alignment with Flow

For the calibration to be valid, the Transducer needs to be horizontally and vertically aligned with the flow. While DOF6000 Transducers are calibrated pointing into the flow, they can be pointed downstream with little loss of calibration accuracy. You may want to do this when fouling of the sensor face is a problem.

Any angled flow in the horizontal plane will reduce the recorded velocity. A 10 degree angle will reduce the velocity recorded by 1.5%.

More significant errors will result from angled flow in the vertical plane. The sensors are manufactured to project acoustic signals at 30° above horizontal when the sensor is mounted horizontally. A 10° vertical flow angle change will cause errors of approximately $+8.5\%$ ($@20^\circ$) and -11.5% ($@40^\circ$).

2.5.2 Conversion of Logged to Mean Velocity

The logged velocity data may have to be adjusted during post processing to reflect a mean velocity for the channel. The factors used will be site specific and have to be determined by the operator. This is done by obtaining a mean channel velocity by conventional techniques and comparing it with the average logged velocity. If necessary this process should be repeated at various discharges.

Where the relationship is complex or unstable, the accuracy of this method is compromised.

In laminar flow conditions the channel mean velocity could be expected to be between 90% and 110% of the logged velocity.

In small channels (say a 500mm diameter pipe) the factor may be close to 100% as a representative area of flow will have been "seen" by DOF6000 Transducer and contributed to the logged velocity.

In larger channels only the area adjacent to transducer will be “seen” and the relationship will depend on how this portion relates to the vertical and horizontal velocity distribution in the channel. An instrument located in the centre of the stream would normally be in a higher velocity area. However in a deep channel transducer may only see the slower portion of the velocity profile.

2.6 Depth Measurement

Water depth is measured using a solid state pressure sensor mounted underneath the DOF6000 Transducer and vented to atmospheric pressure via a vent tube inside the signal cable.

Water pressure is sensed via a pressure damping manifold which has been designed to sense depth in front of the velocity Transducer.

The shape of the sensing manifold is designed to reduce velocity effects on the pressure sensor. These effects are significant at velocities above 2m/sec.

The vent tube is opened to the atmosphere through the signal cable connector.

2.7 Flow Rate Calculations

Most users will record velocity and depth for later analysis. However, Flow Calculator has the capability of performing Flow Rate and Total Flow computations.

From these computed you may display and record Flow Rate and Total Flow (volumes).

PART 3 Specifications

3.1 Specifications

Flow Calculator

	Fixed: NEMA 4X [IP66], Fiberglass
	244L×196W×114H (mm)
Enclosure:	Portable: NEMA 4X [IP65], ABS
	270L×215W×175H (mm)
	Fixed: 85~265VAC, 50/60 Hz ±5%, 5VA Max
	Or 24VDC
Power Supply:	Portable: rechargeable lithium battery, 24VDC, 12Ah, Over 40 hours working time on a full-charge
	Charger: 85~265VAC , 50/60 Hz, 200mA
Outputs:	4-20mA(output load 250-500 Ω), RS485(Modbus), GPRS (optional), SD card to record data
Temperature:	-20 to +60°C

DOF6000 Transducer

	PVC body. Stainless steel mounting plate.
Enclosure:	290mm x 70mm x 25mm (L x W x H)
Weight:	850g (2kg with 15m cable)
Cable:	15 metres, 9 way vented cable «SQL» Compatible
Temperature:	-17°C to 60°C, Resolution: 0.1°C

Velocity

Range: 21mm/s to 4500mm/s bidirectional

Resolution: 1mm/s

Accuracy: 2% of measured velocity

Signal Path: 30° above horizontal

Depth

Ranges: Model 6526H2 0 to 2m
Model 6526H5 0 to 5m

Resolution: Model 6526H2 0 to 1m – 1mm
1 to 2m – 2mm
Model 6526H5 0 to 2.5m – 2.5mm
2.5 to 5m – 5mm

Accuracy: $\pm 0.25\%$ of calibrated lower range

Type: Hydrostatic pressure sensor vented to atmosphere.

Offset 12mm

PART 4 Flow Calculator Installation and Wirings

4.1 Flow Calculator Mounting

Mount flow calculator in a location that is:

- Where little vibration exists
- Protected from falling corrosive fluids
- Within ambient temperature limits -20 to +60°C
- Out of direct sunlight. Direct sunlight may increase transmitter temperature to above the maximum limit

4.2 Flow Calculator Wirings

Fixed Flow Calculator Wirings



Fixed Flow Calculator Wiring Diagram

- ◆ In the right of above picture is AC85-265V which is connected to external power supply.
- ◆ DC24V is connected to external 24VDC power supply.
- ◆ RS232 is connected to transducer four wires cable.
- ◆ 12VOUT is connected to transducer power supply.
- ◆ I-OUT is 4-20mA output interface.
- ◆ MODBUS "A B" is RS585 output interface.
- ◆

Portable Flow Calculator Wires

The portable DOF6000 flow meter is equipped with a rechargeable lithium battery. This battery will require charging before initial operation. Apply 85~265VAC power, utilizing charging adapter and charging cable to the portable flow meter for a period of 8 hours prior to using the product for the first time. The charging connection located on the side of the enclosure as label.

The portable flow meter's integral battery provides continuous operation for up to 40 hours on a full-charge. To obtain the greatest capacity and longevity from the battery, the following practices are recommended:

- Do not allow the battery to completely discharge. (Discharging the battery to the point where the LOW BATTERY indicator illuminates will not damage the battery. Allowing the battery to stay discharged for long periods of time can degrade the storage capacity of the battery.)

NOTE: Commonly, the battery is charged for a period of 6-8 hours and needn't over charge. Unplug from line power when the CHARGING indicator goes out.

- If the portable flow meter is stored for prolonged periods of time, monthly charging is recommended.
- If the portable flow meter is stored for prolonged periods of time, had better store at a temperature below 70°F [21°C].



Transmit Output Power

4.3 Flow Calculator Overview



Wall-mounted flow calculator



Portable flow calculator

4.4 Flow Calculator wirings and Mounting Dimensions

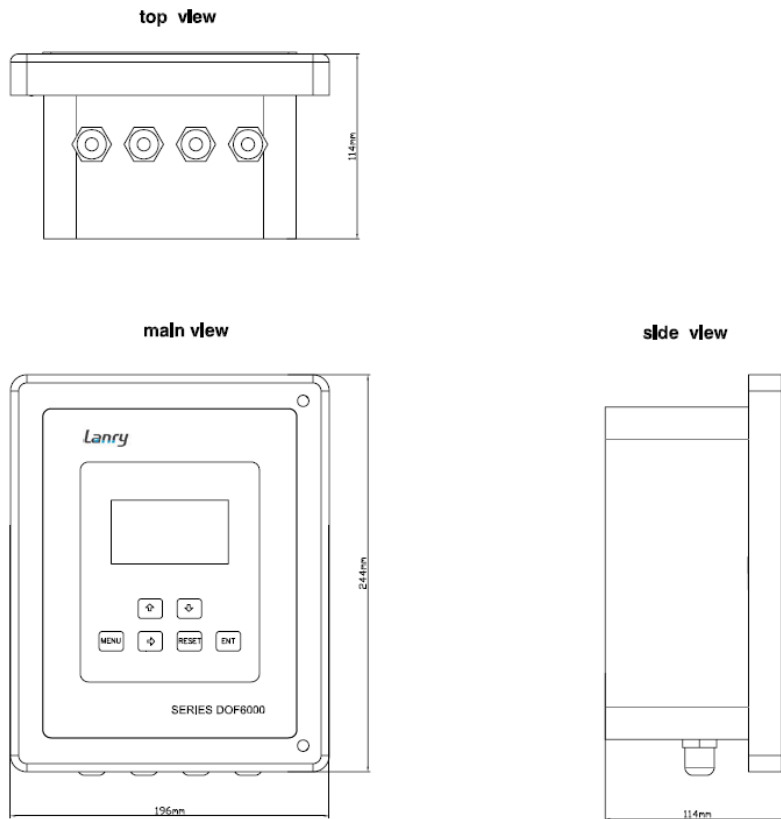

Wall-mounted Flow Calculator Mounting Dimensions

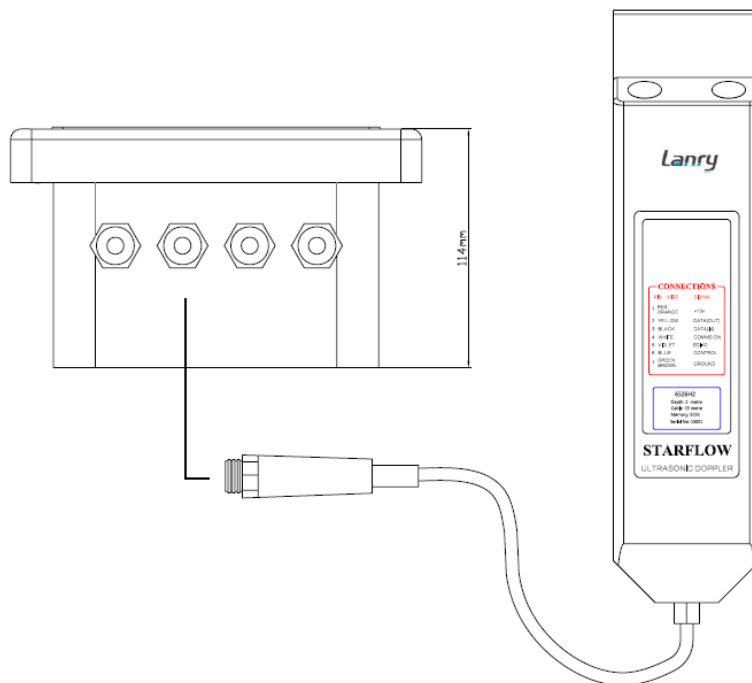

Wall-mounted Flow Calculator wirings

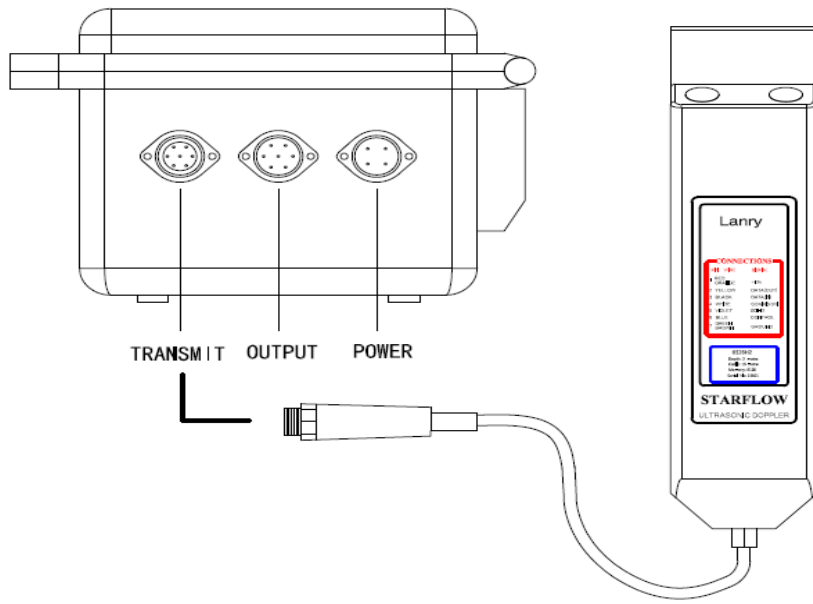

Portable Flow Calculator wirings

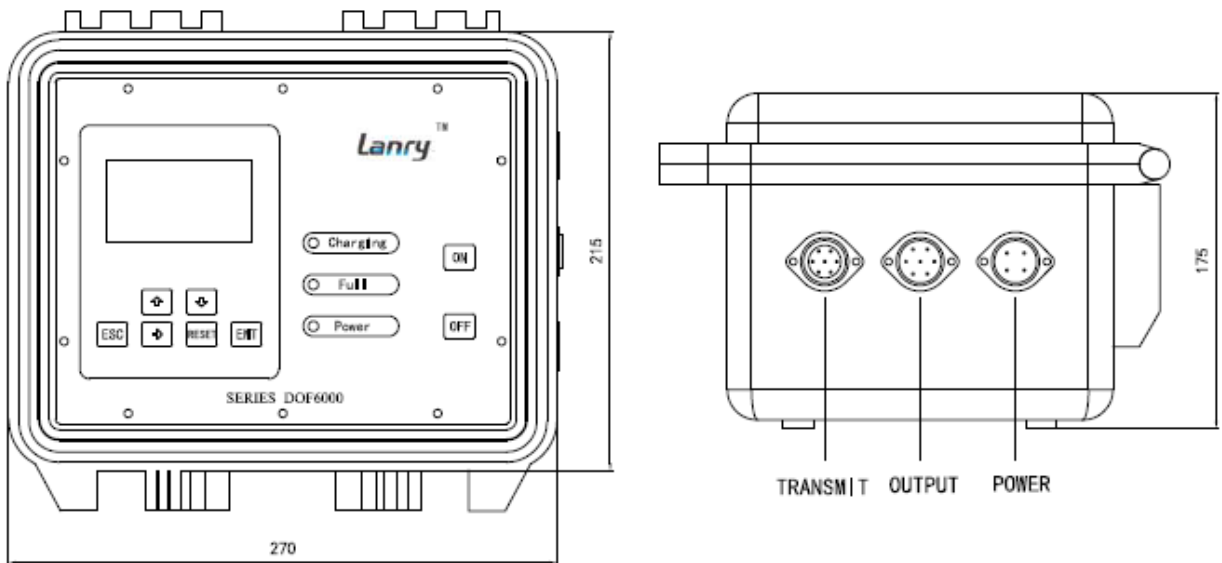

Portable Flow Calculator Mounting Dimensions

PART 5 DOF6000 Transducer Installation and Wirings

DOF6000 Transducer is a very effective alternative to conventional flow measuring installations for small streams. DOF6000 Transducer is unobtrusive and ideally suited to flow conditions in culverts, channels and drains. Cost, maintenance and environmental impact of new installations is minimized by avoiding the construction of conventional flow measuring structures.

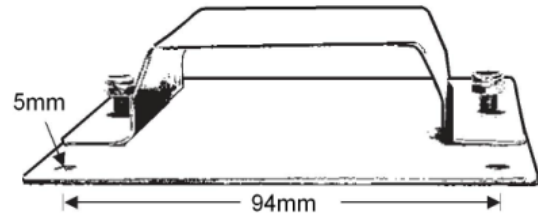

5.1 DOF6000 Transducer Mounting

A versatile mounting bracket is available to secure a DOF6000 Transducer Instrument into a channel or a pipe. Loosening the nuts enables the instrument to be removed for inspection. The bracket saddle locks the instrument into its correct position and alignment.

Before Tightening Mounting Bracket ...

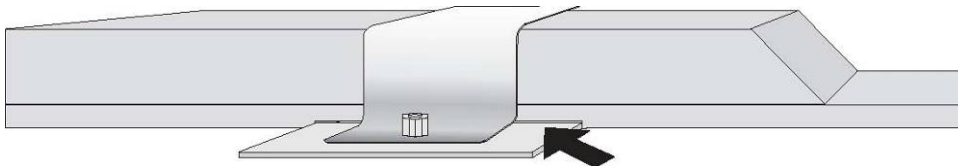

Check there is no debris between it and the DOF6000 Transducer.

Do not over tighten!

5.2 Locating DOF6000 Transducer

A typical installation is in a pipe or culvert with diameters between 300 and 5000 mm. DOF6000 Transducer should be located near the downstream end of a straight and clean culvert, where non-turbulent flow conditions are maximised. The mounting should ensure the unit sits right on the bottom to avoid debris catching beneath it.

When installing transducer in pipes or culverts, users can directly weld the mounting bracket in pipe, and then put the transducer into mounting bracket. Or users can make an expanding hoop shown as below, weld the mounting bracket on it, put the transducer into the mounting bracket, and then fix the whole component into pipes.

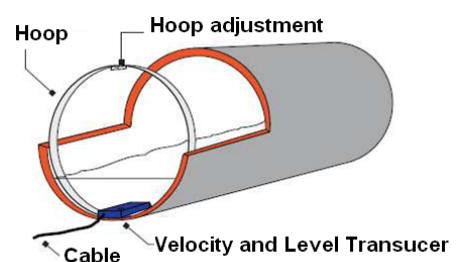
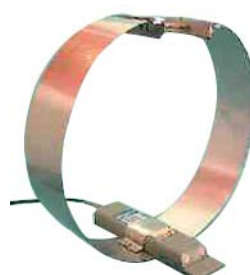

In culverts the transducer can be mounted on a stainless steel hoop that is slipped inside the pipe and expanded to lock it in position. In open channels special mounting brackets may be required. Special protection from vandalism and interference may also be required.

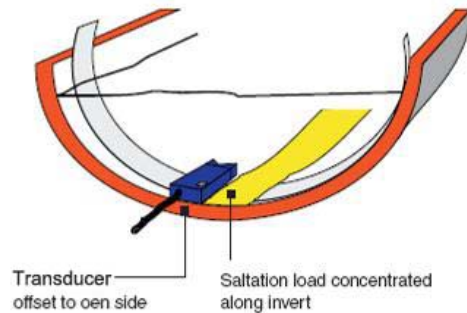

The transducer can be located at the invert of the pipe but may be better located slightly to one side of the invert to avoid alluvial material or heavy debris transported during higher flows. It will not be affected by being located partly up the side of a pipe provided it remains aligned with the flow. For details of installing DOF6000 Transducer in a pipe using the Expanding Hoop see the Appendix.

The transducer can also be located in the bed of a natural or artificial channel. Again it should be installed and located in such a way as below to avoid accumulating debris, being buried by alluvial material or getting washed away. The cable should be protected from damage.

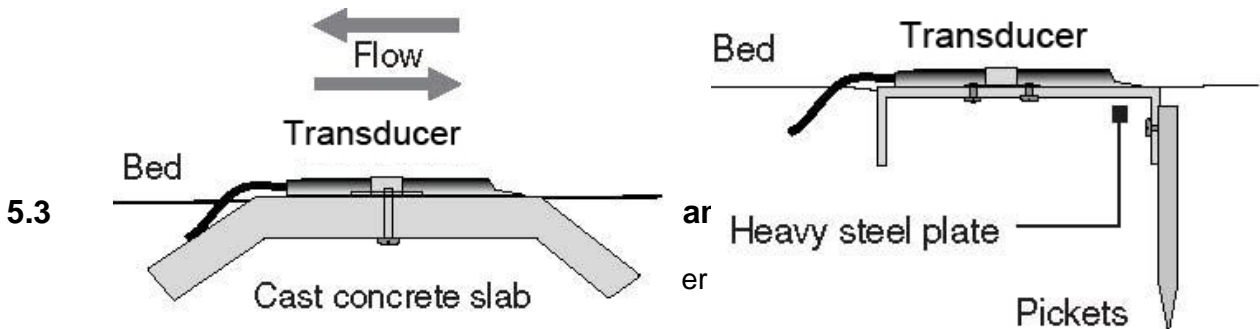

Pointing the transducer end downstream will stop it accumulating debris, however in some channels the transducer body may disturb the velocity distribution unacceptably.

The velocity reading will be positive when pointing upstream and negative when pointing downstream. DOF6000 Transducer may be configured to only read positive velocities regardless of water flow direction.

5.4 Power Considerations

DOF6000 Transducer is powered from 12VDC output of flow calculator connected to the signal cable.

If customers use a battery to power supply, the battery is not continuously recharged either by a solar recharge system or some other recharge system, it may require replacement.

If the 12V power falls below 11.5V, the DOF6000 Transducer will stop recording (it enters "Sleep Mode.")

5.5 Signal Cable and Connections

DOF6000 Transducer comes with a 15 metre multi-core, vented signal cable which is terminated into a 7 pin «SQL» weatherproof connector.

The cable connectors are «SQL» compatible and may be extended with «SQL» extensions (or other suitable quality signal cable) up to 35 metres.

5.6 DOF6000 Transducer Connection Table

9 Wire Vented Cable SQL Pin#	Wire Colour	Power Supply Cable	Signal Description
1		Red	+12VDC
2	Yellow		RxD(Receive)
3	Black		TxD(Send)
4	White		RST(Request to Send)
7		Brown	signal ground

The table is for fixed flow meter..

PART 6 Flow Calculator Operation

6.1 General

DOF6000 flow meter contains a six-key tactile feedback keypad interface that allows user to view and change configuration parameters used by the flow meter operating system.

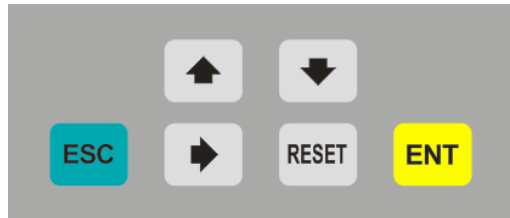

6.2 Key Instruction

(1) **ESC** Key

When choose menu, press it to return superior menu;

When set parameters, press it to cancel the setting, the setting parameter is invalid, and return the last parameter.

(2)  Key

When choose menu, press it to see the follow menus;

When set parameters, press it to shift the flashing position to right.

(3)  and  Key

When choose menu, press them to shift the flashing position up or down to select menu users need;

When set parameters, press them to change the value.

(4) **ENT** Key

When choose menu, press it to select menu users need;

When set parameters, press it to save the setting.

(5) **RESET** Key

Press it to restart the meter.

6.3 Menu Structure

When DOF6000 is powered on, the screen displays main menu, the main menu is shown as follow:

Depth: 27mm
Veloc: 0.050m/s
Flow: 0.145 m3/h
Total: 13.97220 m3

Note: When setup parameter in flow calculator, must connect transducer to flow calculator, if not, pressing key is invalid.

Press  Key from main menu to enter time menu, the time menu displays current date and time.

Press ENTER Key from main menu or time menu to enter setting menu.

In setting menu, it has six setting items.

6.3.1 Set pipe type, press ENT Key to enter submenu:

AreaWay: Pipe – circular pipe

Rect – Rectangular pipe or channel

UserR - user define

Pipe: Set_Diam – diameter of circular pipe

Set_Offset – height from bottom of pipe to installation location of transducer

Set_Deadse – dead sector of circular pipe, when the level in pipe is lower than dead zone, flow meter will not calculator flow rate.

Rectangle: Width – width of rectangle

UserRating: user define

When customers select Rect/UserR, and install the DOF6000 Transducer, this situation maybe produces an offset area in cross-sectional area. The offset area for rectangle and UserRating is set by Set_Area in Service menu.

6.3.1 Communication

Communication setting for GPRS.

Time Check: modify the current date and time.

6.3.2 **Output**

Output setting

4-20mA: setting 4-20mA, press ENT key to setting representative flow value of 4mA and 20mA

RS485: Baud: serial communication baud rate

Parity:

None

Odd: odd parity

Even: even parity

MODBUS Addr: MODBUS protocol address

6.3.3 **Data logger**

Enable: function selection

Open: enable data storage function

Close: disable data storage function

Save.TM: the time interval of data logging, users can select "1m, 5m, 30m, 60m, No". The logging data includes date and time, depth, velocity, flow rate and total flow.

IN: 00000 m3/h, Spare function

Note: The name of the file in SD card is mm-dd-hh-xx, xx means the file's number.

6.3.4 **External L&V**

Input external level and velocity, **for DOF6000, the Enable must select "Close"**.

Enable: function selection

Open: enable external level and velocity input

Close: disable external level and velocity input

Level: set level

RangH: Range upper limit

RangL: Range lower limit

Start: begin to zero, when the external input is a 4-20mA signal, the Start value is 1.000V (4mA*250Ω).

Velocity: set velocity

RangH: Range upper limit

RangL: Range lower limit

Start: begin to zero, when the external input is a 4-20mA signal, the Start value is 1.000V (4mA*250 Ω).

6.3.5 Service

Input password **021573** to enter service menu.

Set_Rato: Set instrument factor.

Set_Zero: The manual zero point for velocity. The unit is **m/h**.

Total: Check and modify the totalizer.

V_Damp: Velocity damping for displaying a stable read. The input range is 0-150s, default setup is 30s.

L_Damp: Level damping for displaying a stable read. The input range is 0-20s, default setup is 5s.

Set_Area: Offset area for Rectangle and UserRating. The unit is m².

6.4 Application Example

6.4.1 Partially Filled Pipe Examples

There are three parameters needed to define a pipe installation.

Offset (mm) This defines the offset from the bottom of the pipe to the position of the DOF6000 Transducer depth sensor. This is usually 10mm, however, in some installations the DOF6000 Transducer may be located away from the bottom (to avoid silt and rubbish).

Pipe Diameter (mm) Defines the pipe diameter.

Dead Sector (mm) The dead band due to siltation (if any).

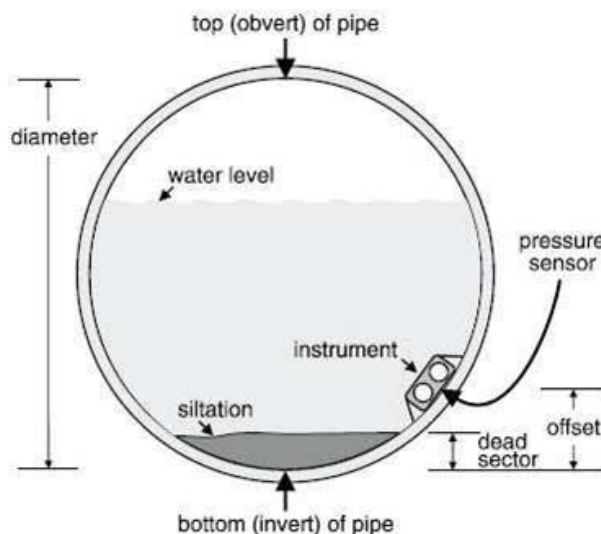

Pipe Example 1

Pipe is 1.8m in diameter.
 A DOF6000 Transducer unit is mounted at the bottom.
 No silt (dead sector) in pipe.

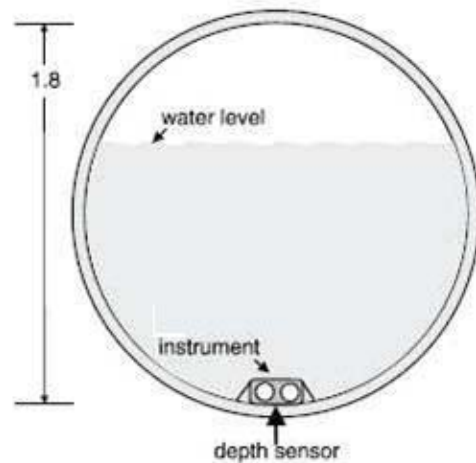

Flow Calculator Setting:

Select "Close" in External L&V;
 Select "pipe" in AreaWay;
 Set Set_Diam "1800" in Pipe;
 Set Set_Offset "0015" in Pipe, this value is maybe adjusted through the site;
 Set Set_Deadse "0000" in Pipe.

Pipe Example 2

Pipe is 900mm in diameter.
 A DOF6000 Transducer unit is mounted 100mm up from the bottom and there is 75mm of silt in the pipe.
 Maximum depth in this application is 800mm (less than 1m).

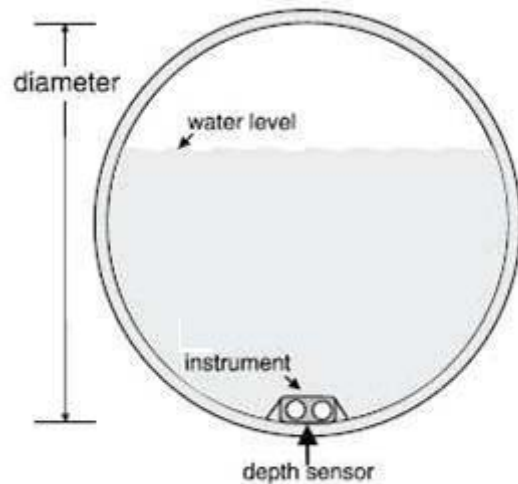

Flow Calculator Setting:

Select "Close" in External L&V;
 Select "pipe" in AreaWay;
 Set Set_Diam "0900" in Pipe;
 Set Set_Offset "0112" in Pipe;
 Set Set_Deadse "0075" in Pipe.

6.4.2 Open Channel Examples

The open channel is 3000mm width.
 A DOF6000 Transducer unit is mounted at the bottom.
 No silt (dead sector) in channel.

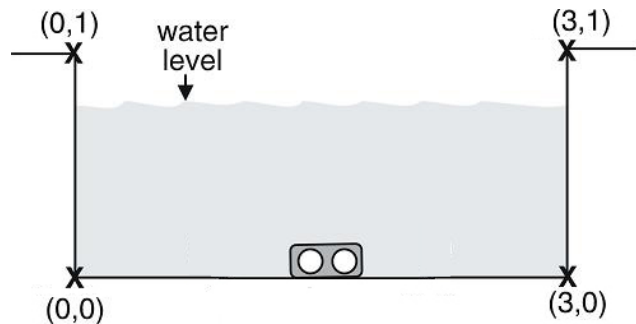

Flow Calculator Setting:

Select "Close" in External L&V;
 Select "Rect" in AreaWay;

Set "3000" in Rectangel.
 Set Offset: Set_Area of 0.036 approximately.

6.4.3 User Define Examples

User Define Example 1

The channel is triangular as shown. A DOF6000 Transducer unit is mounted at the bottom.

No silt (dead sector) in channel.

Flow Calculator Setting:

Select "Close" in External L&V;
 Select "UserR" in AreaWay;
 Set Point01 "0000, 1500" in UserRating.
 Set Point02 "1000, 0000" in UserRating.
 Set Point02 "2000, 1500" in UserRating.
 Set Offset: Set_Area of 0.011 approximately.

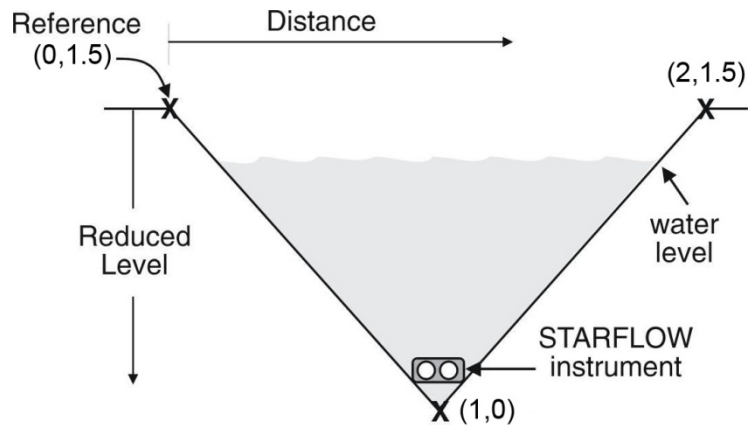

User Define Example 1

The channel is as shown. A DOF6000 Transducer unit is mounted at the bottom.

No silt (dead sector) in channel.

Rectangel

Flow Calculator Setting:

Select "Close" in External L&V;
 Select "UserR" in AreaWay;
 Set Point01 "0000, 1300" in UserRating.
 Set Point02 "0000, 0300" in UserRating.
 Set Point03 "1000, 0300" in UserRating.
 Set Point04 "1000, 0000" in UserRating.
 Set Point05 "2000, 0000" in UserRating.
 Set Point06 "2000, 0300" in UserRating.
 Set Point07 "3000, 0300" in UserRating.
 Set Point08 "3000, 1300" in UserRating.
 Set Offset: Set_Area of 0.012 approximately.

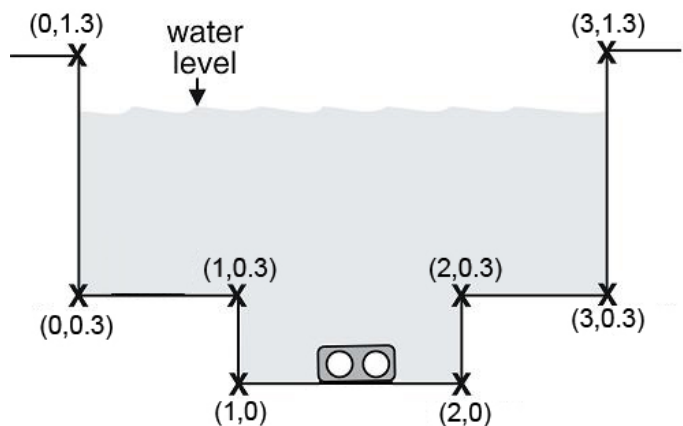

6.5 Offset Area Setting

There is 12mm distance from pressure sensor and transducer bottom, so, this situation will produce an offset area in cross-sectional area. When use DOF6000 Transducer, it needs to set 12mm offset.

When customers select "Pipe" to measure, and install the DOF6000 Transducer, if transducer is installed on the bottom, the offset maybe is 12mm, or maybe is more than 12mm (Due to the pipe shape). If transducer is installed on the side, the offset is calculated according to the site. The offset(mm) is set by "Set_offset" menu.

When customers select "Rect" to measuring, and install the DOF6000 Transducer, if transducer is installed on the bottom, the offset is 12mm. For example, the width of rectangle channel is 1000mm, the offset zone is $0.012\text{m}^2(1\text{m}\times 0.012\text{m})$. If the transducer is installed 100mm distance from the channel bottom, the offset is 112mm, the offset area is $0.112\text{m}^2(1\text{m}\times 0.112\text{m})$. The offset area is set by "Set_Area" in "Service" menu.

When customers select "UserR" to measuring, and install the DOF6000 Transducer, if transducer is installed on the bottom, the offset is 12mm. For example, the open channel is shown as below, the offset are is $0.010\text{m}^2[(2-1)\text{m}\times 0.010\text{m}]$. The offset area is set by "Set_Area" in "Service" menu.

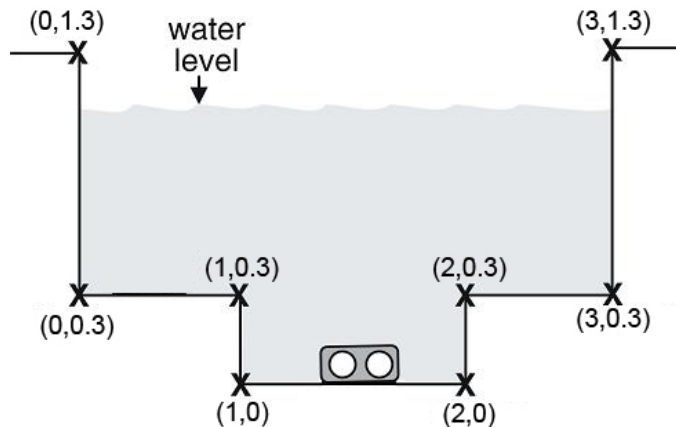

If the transducer is installed shown as the following picture, the offset area is $0.336\text{m}^2 [(2-1)\times(0.3-0)+(3-0)\times 0.012=0.336]$.

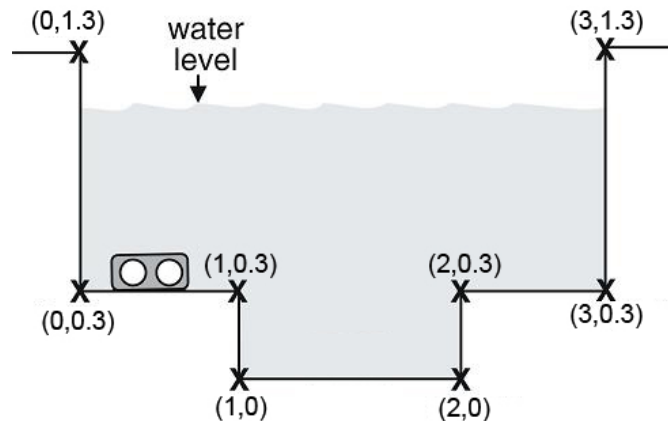

PART 7 Warranty and Service

7.1 Warranty

The manufacturer provides one year warranty on all products, free of charge, but the users should be responsible for the one-way transportation fee from the customer to the factory.

7.2 Service

The manufacturer provides instrument installation for our customers, and the charges will be made according to the cost.

For any hardware failure of the instrument, we recommend that our customers send back the instrument to our factory for service, due to the fact that the instrument is made of microprocessors and it will be difficult to perform field maintenance. Before sending back the instrument, please try to contact the factory first to make sure what the problem is.

For other operational problems, please contact our local distributor by telephone, fax or email. In most cases, the problem could be solved immediately.

Appendix A – Installation Checklist

Installation Steps

Installing DOF6000 Instrument

Do the following:

- 1 Locate DOF6000 Transducer in such a way to avoid accumulating debris, being buried by alluvial material or getting washed away.
- 2 Ensure that you have enough cable to reach flow calculator.
- 3 Locate flow calculator in such a way to avoid sunlight, corrosive fluids and vibration.
- 4 Connect DOF6000 Transducer to flow calculator, including power line and communication line.
- 5 Set Enable of External L&V to be closed, and then you can see the display of flow calculator to check whether DOF6000 instrument works well.

Note: When setup parameter in flow calculator, must connect transducer to flow calculator, if not, pressing key is invalid.

Appendix B – Communication Protocol

When using RS485, connect the output from “OUT RS485” terminal, and set flow calculator “4800, none”.

Modbus_RTU protocol Map

Register Address	Length	Description	Data Format
0000H	2	Level	IEEE754 floating point
0002H	2	Velocity	
0004H	2	Flow Rate	
0006H	2	Totalizer	
0008H	2	Current Cross Sectional Area	

Modbus_RTU protocol Explanation

Communication protocol has function code 03, and use 16 bits CRC cyclic redundancy check.

If need to read all data, send a command:

01 03 00 00 00 0A C5 CD

01: MODBUS address in flow calculator.

03: Function code.

00 00: Start data address.

00 0A: From address 00 00, there are 20 bytes data.

C5 CD: 16 bits CRC cyclic redundancy check.

Return:

01 03 14 42 C8 E2 E1 41 AC 8A EE 41 E8 EE C1 3F CB 73 A0 3E C0 00 00 3D 95

01: MODBUS address in flow calculator.

03: Function code.

14: Data length of return data.

42 C8 E2 E1: Level (100.44)

41 AC 8A EE: Velocity (21.567)

41 E8 EE C1: Flow rate (29.116)

3F CB 73 A0: Totalizer (1.5894)

3E C0 00 00: Cross sectional area (0.375)

3D 95: 16 bits CRC cyclic redundancy check.

The format of the data (level, velocity, flow rate, totalizer, cross sectional area) is IEEE754 floating point.

Appendix C – Expanding Hoop

The expanding hoop allows you to install a DOF6000 Transducer instrument into a pipe.

Features

Modular – The design is modular, allowing it to fit into any size pipe. The hoop is flexible enough to fit irregular shapes, such as ovoid (egg shaped) sections.

Robust – All components are made from stainless steel and the hoop fittings are 100mm wide to fit the standard DOF6000 Transducer mount.

Adjustable – Although pipes come in standard diameters, their dimensions are not always accurate. This means that an expanding hoop system must allow the installer to make adjustments on site. To achieve this, the expanding hoop system is made so that general assembly can be done in the workshop, whilst adjustments can be made in the field with hand tools. An expanding turn-buckle locks the hoop into the pipe.

1.1 Hoop Size Selection

To determine what components are needed for a DOF6000 Transducer pipe installation, you need to know the pipe diameter.

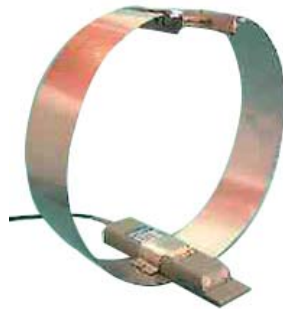

Model	Pipe Size	Joiners
OP-H1	Up to 600mm	-
OP-H2	600mm-1200mm	1
OP-H3	1200mm-1800mm	2

- Pipes less than 300mm diameter are NOT RECOMMENDED FOR DOF6000 Transducer INSTALLATION due to instrument's size.

1.2 Installation

To prepare and install the DOF6000 Transducer into a pipe, you need:

- OP-H Expanding hoop.
- Medium size adjustable spanner.
- Bolts
- Screw caps
- Measuring tape.
- Electric drill.
- Hand “pop rivet” tool.
- Heavy duty metal shears.

Do the following:

1 Arrange hoop(s), bolt and screw caps so that DOF6000 Transducer unit will be positioned at the bottom (invert) of the pipe and a bolt at the top (obvert) of pipe (see in the following diagram).

2 Drill 2 x 5mm holes, 94mm spaced in the centre of the hoop to locate the transducer (see diagram next page).

Use a small pilot drill bit (about 2mm) then finish with the 5mm bit. (When drilling stainless steel, DO NOT stop once drilling has begun, as this will immediately blunt the drill bit.)

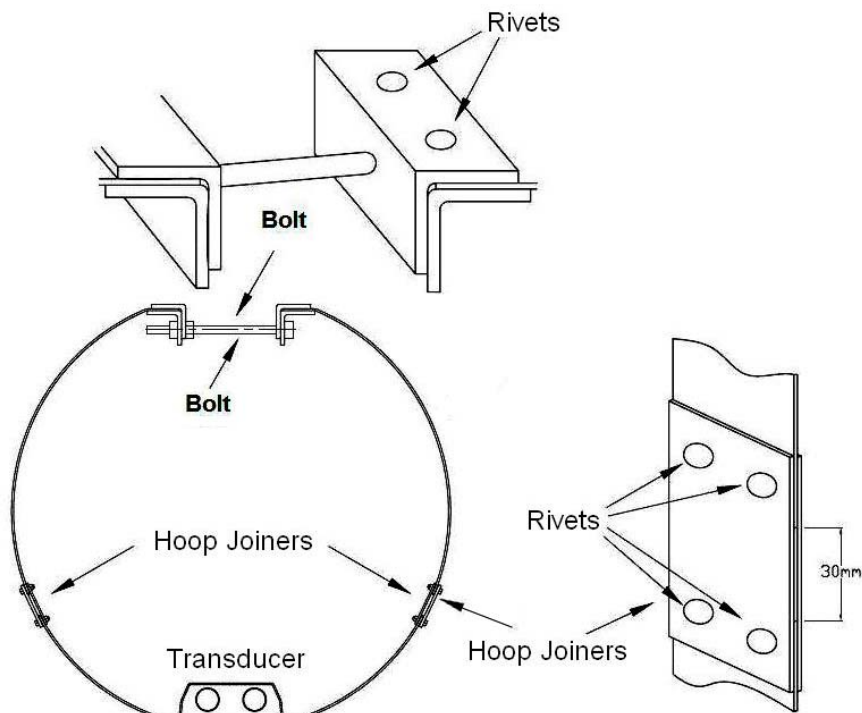

3 “Pop rivet” the hoop sections together (if required) and “pop rivet” the end of one band to the bolt (see diagram). Note: if a “pop rivet” tool is not available, use M3 x 6mm stainless steel self tapping screws (screwed inner to outer).

4 If the inside circumference of the pipe is ACCURATELY known, then cut the hoop assembly to this length LESS 25mm for fitting clearance. (Circumference = Diameter x 22/7)

- Note: the hoop length must be measured to include the bolt (fully closed), hoops and joiners all together as shown.
- Note: if you are unsure of the pipe dimensions, make the final measurement on site and cut the hoop assembly to suit the pipe. Our expanding hoop can be adjusted for more (or less) 20-30mm.

Position and tighten DOF6000 Transducer and hoop, then:

1 Mounting the Mounting bracket to the hoop (see in the following diagram).

2 Fold the hoop into a circle to easily fit inside the pipe.

3 Position into place inside the pipe.

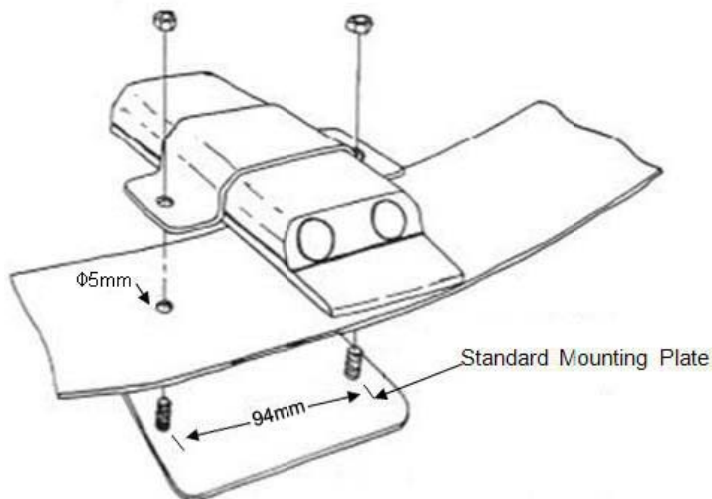

4 Adjust bolt until hoop is tight inside pipe (use spanner if necessary).

5 Slip DOF6000 Transducer unit into mount and tighten.

Lanry

Lanry Instruments (Shanghai) Co.,Ltd

Add: 6 Floor, Block F, Bldg 5, No.2800 Jiuxin Rd., Songjiang District, Shanghai 201612, China

Tel: 86 21-67801665, 67618991

Fax: 86 21-67801625

<http://www.lanry-flow.com>

Mail: info@lanry-flow.com